

1

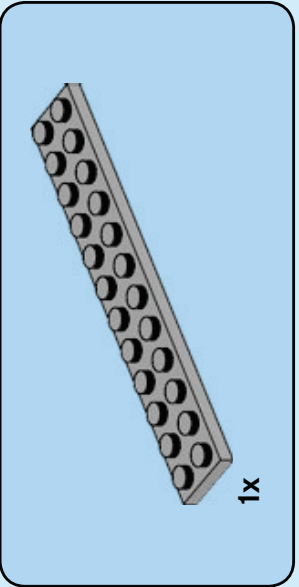

2

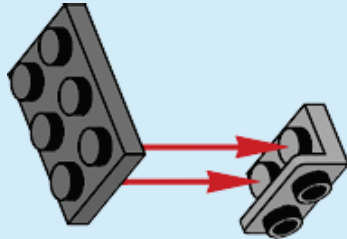

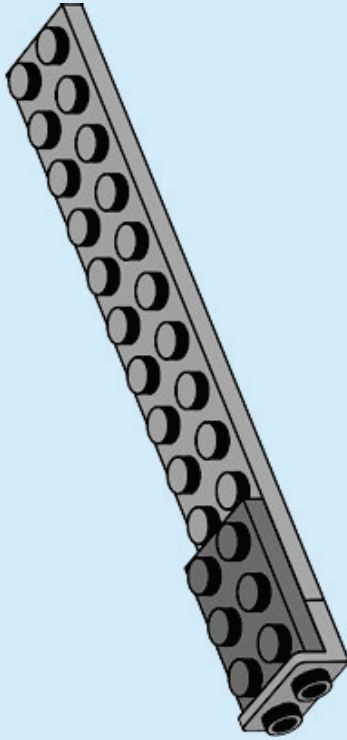
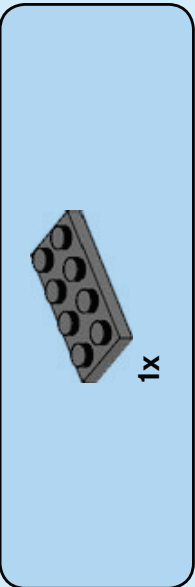

3

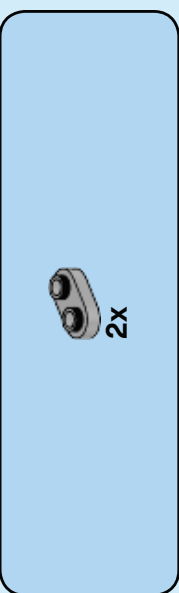
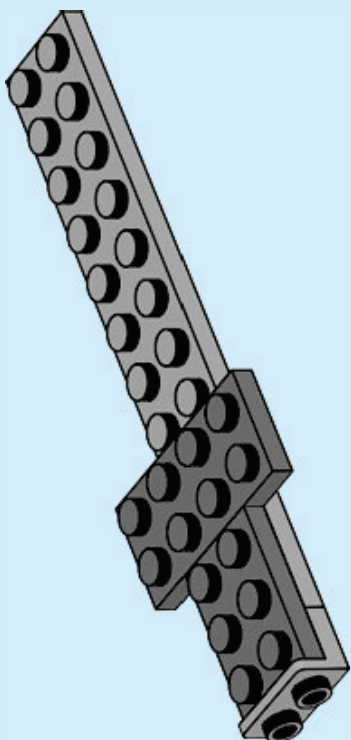

4

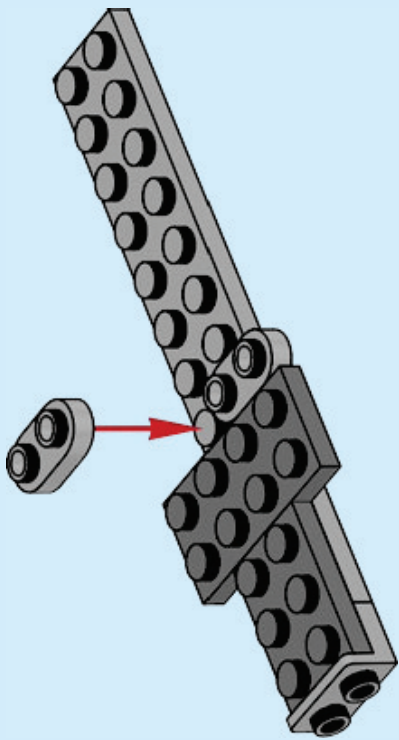

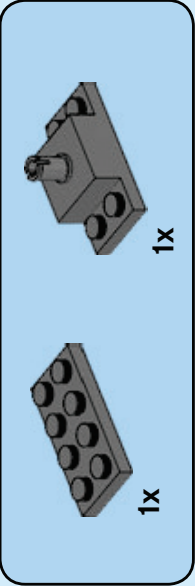

5

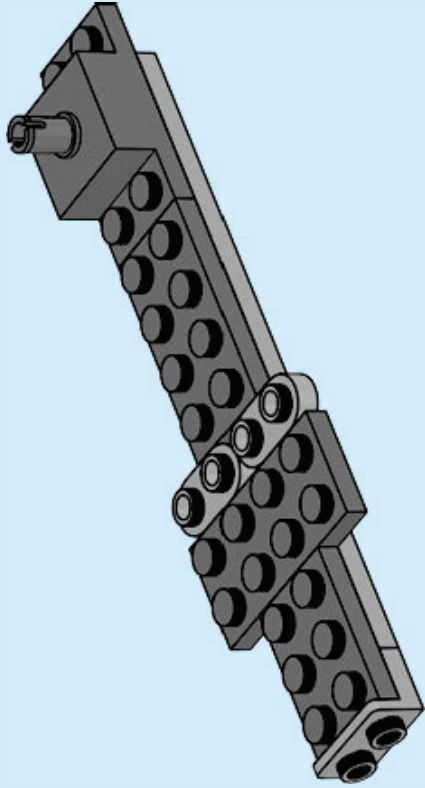

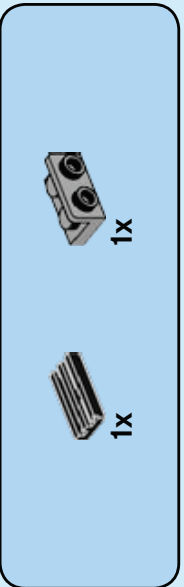

6

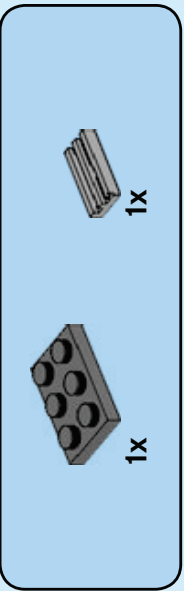
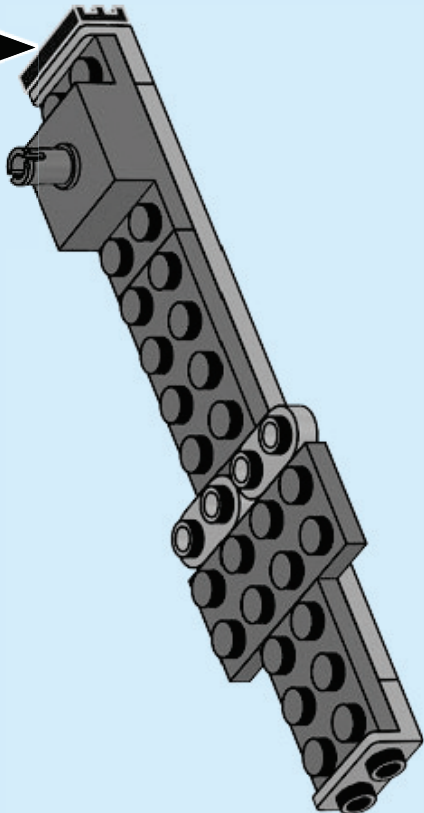
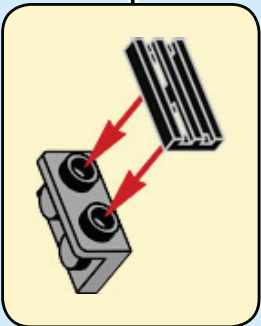

7

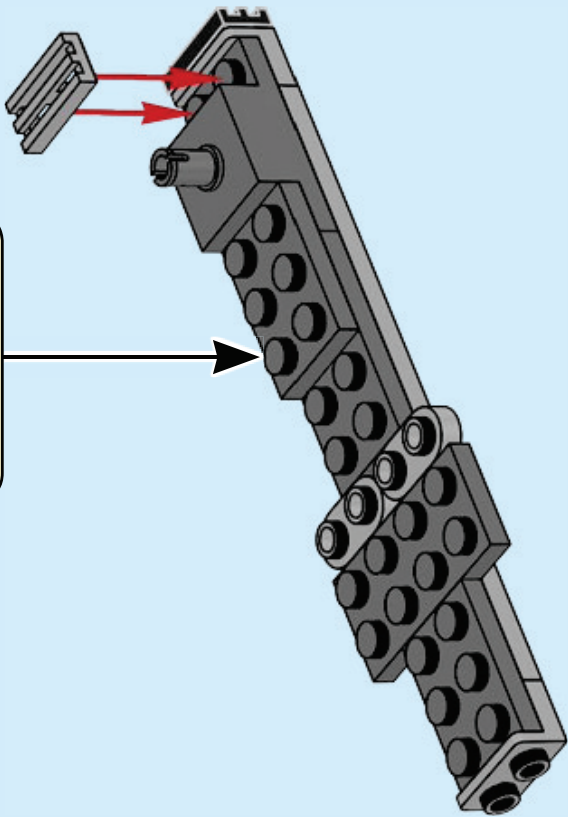
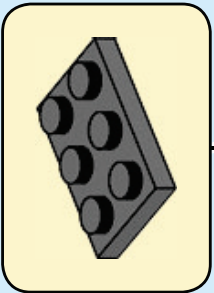

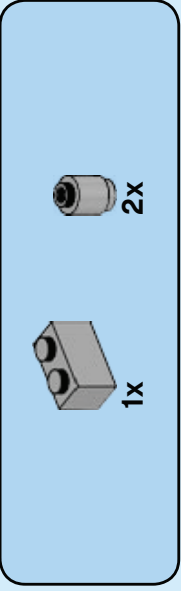
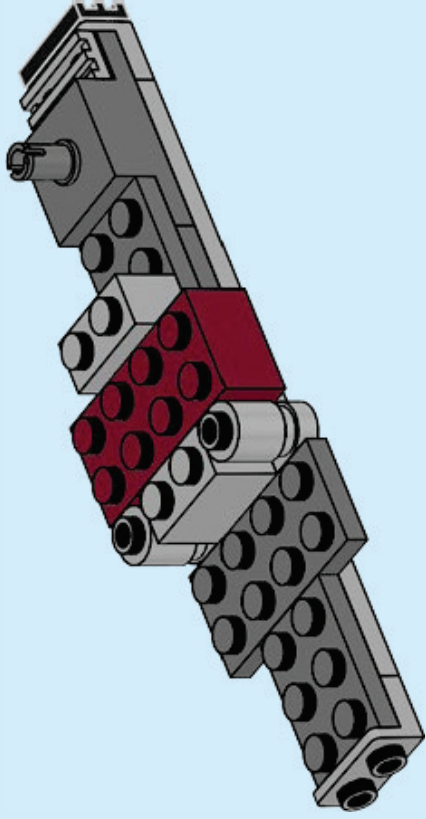

9

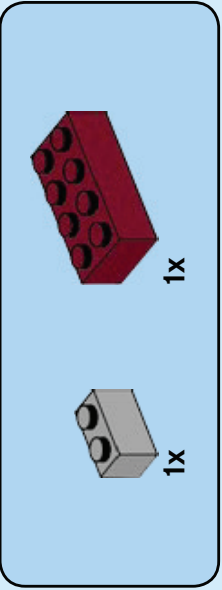
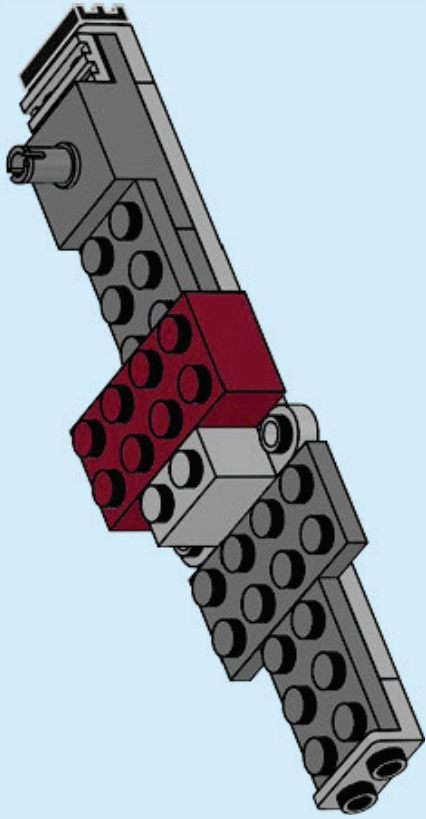

8

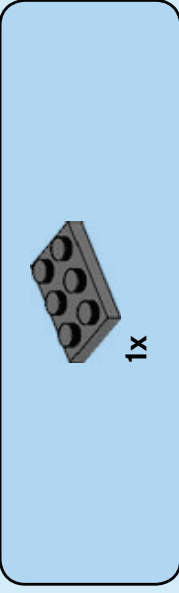
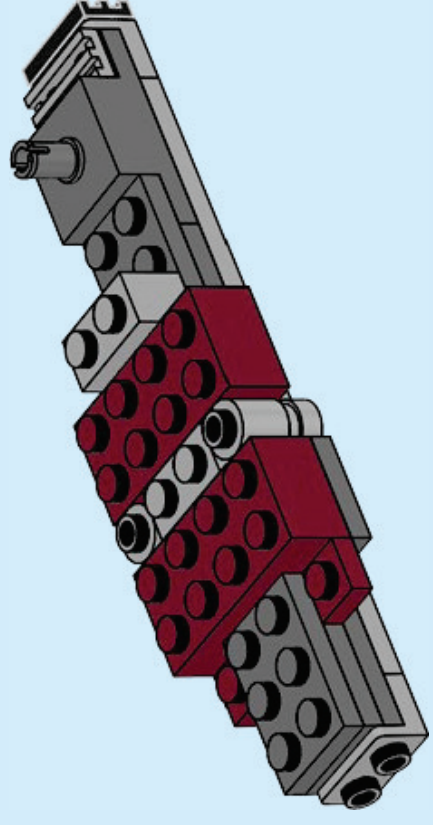

11

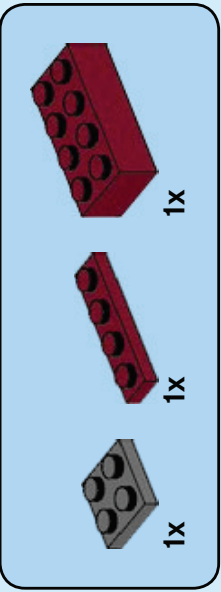
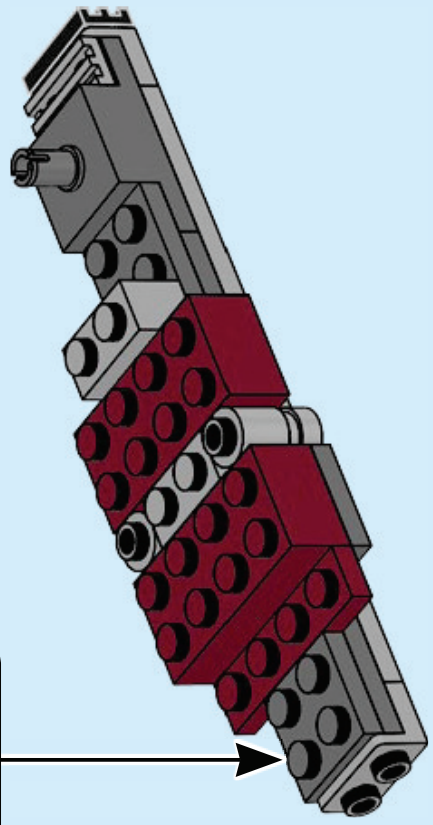

10



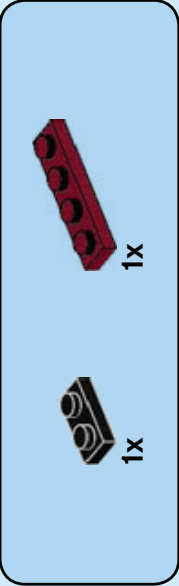

12

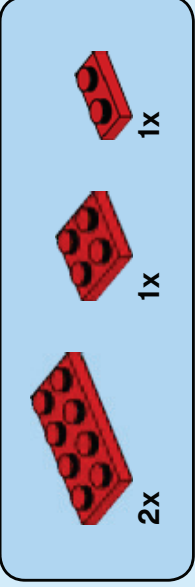
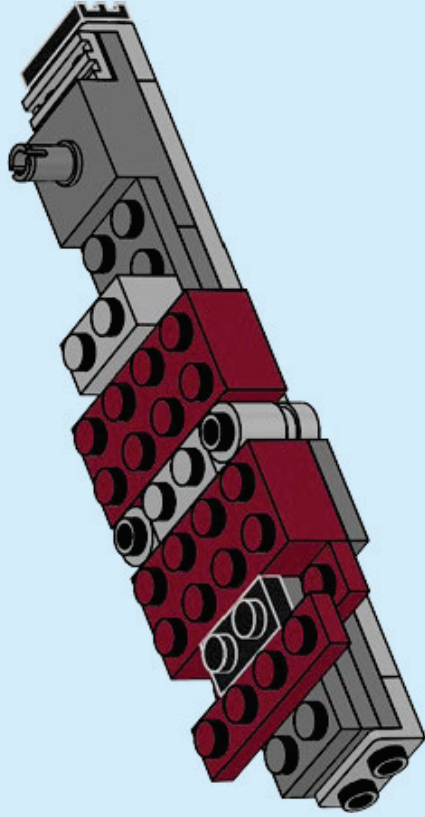

13

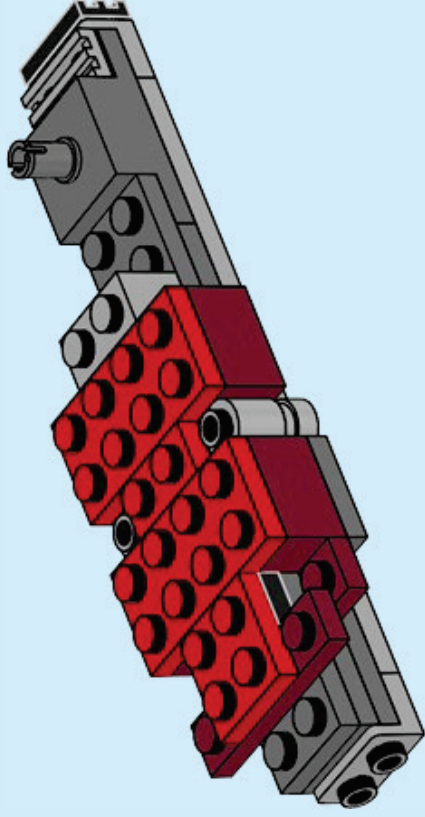

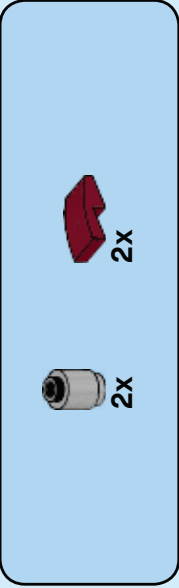

14

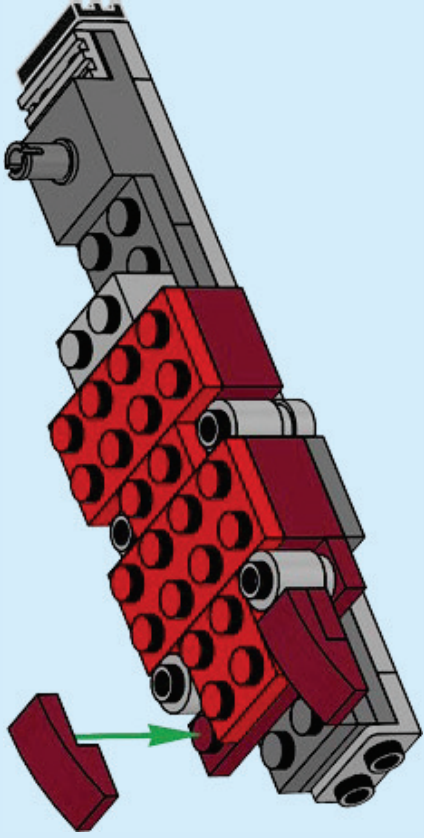

15

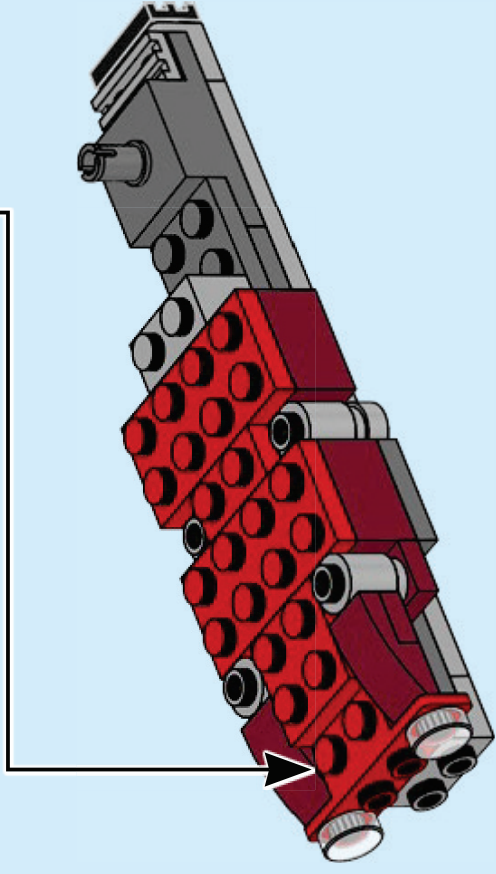
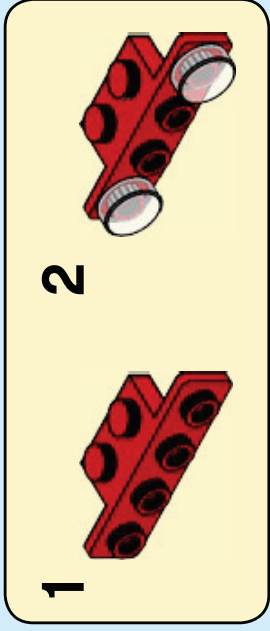

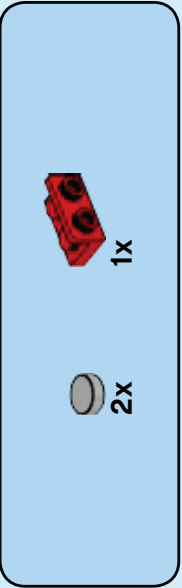

16

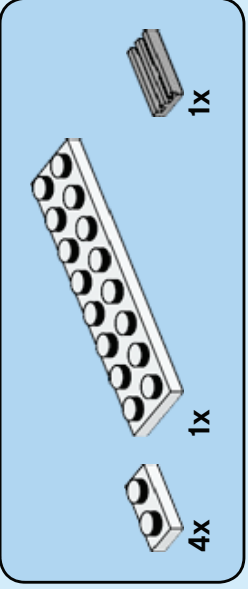
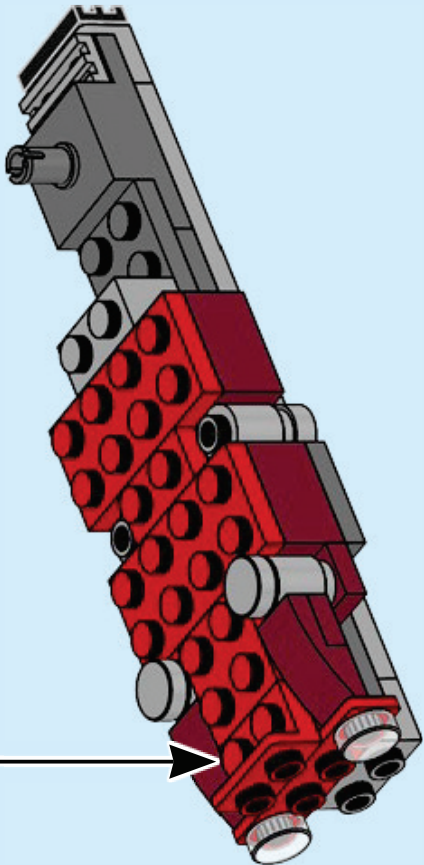

17

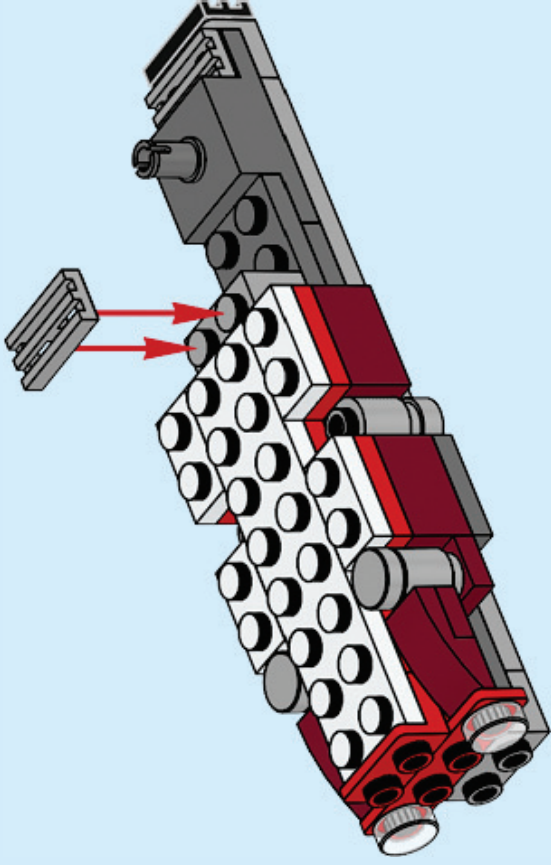

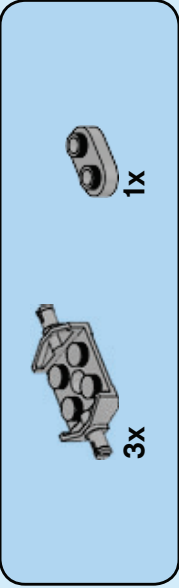

18

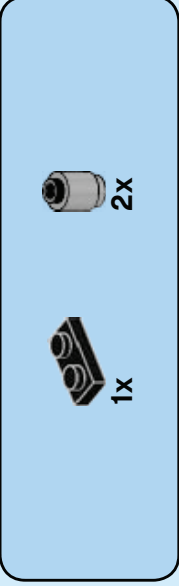
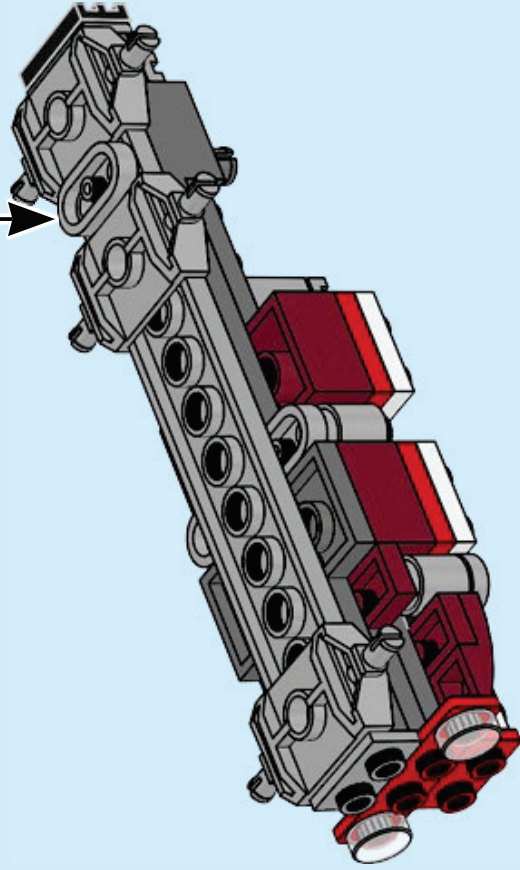
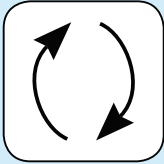

19

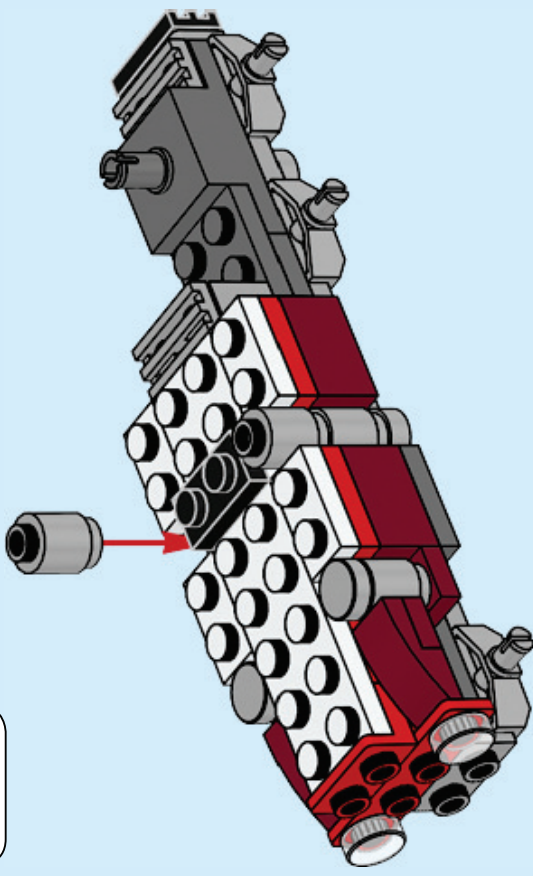
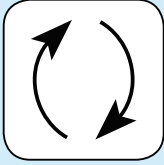

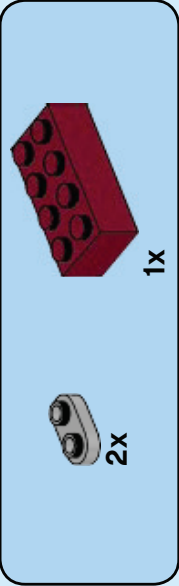

20

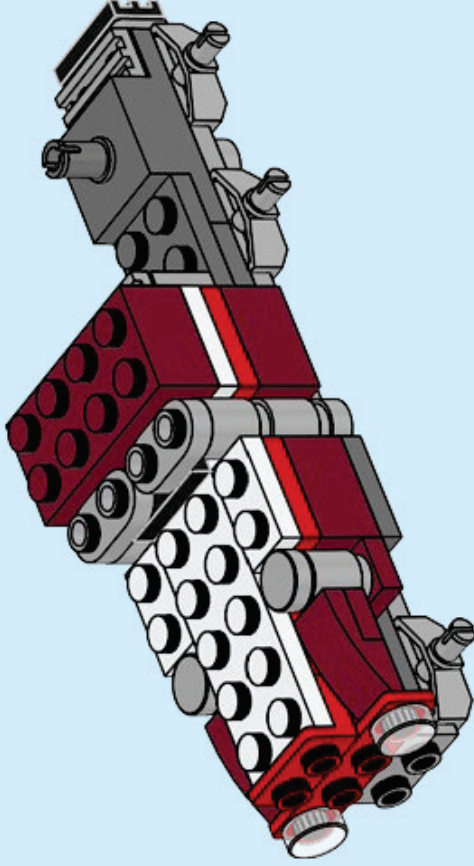

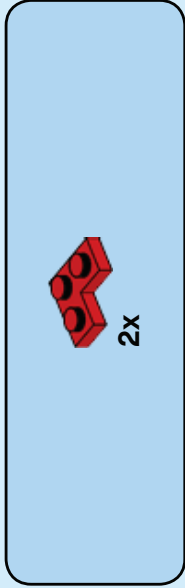

21

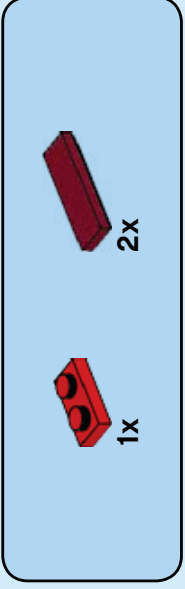
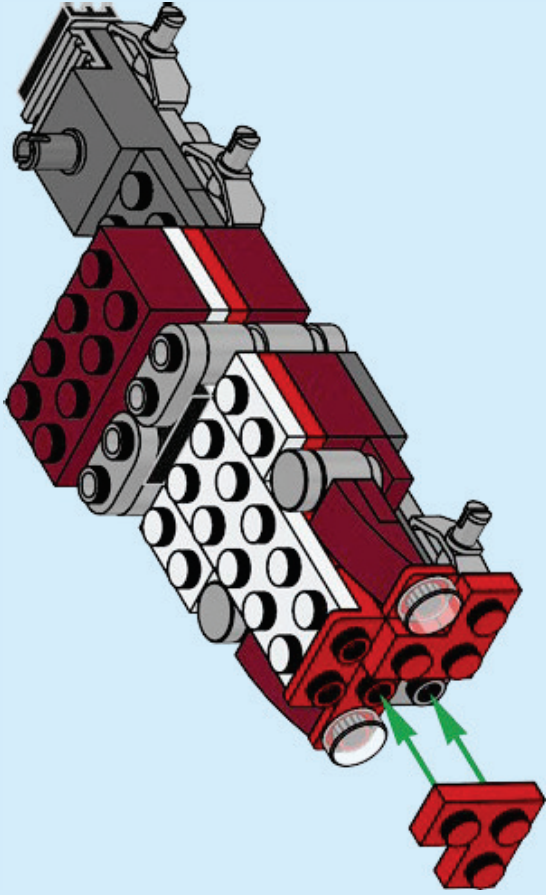

22

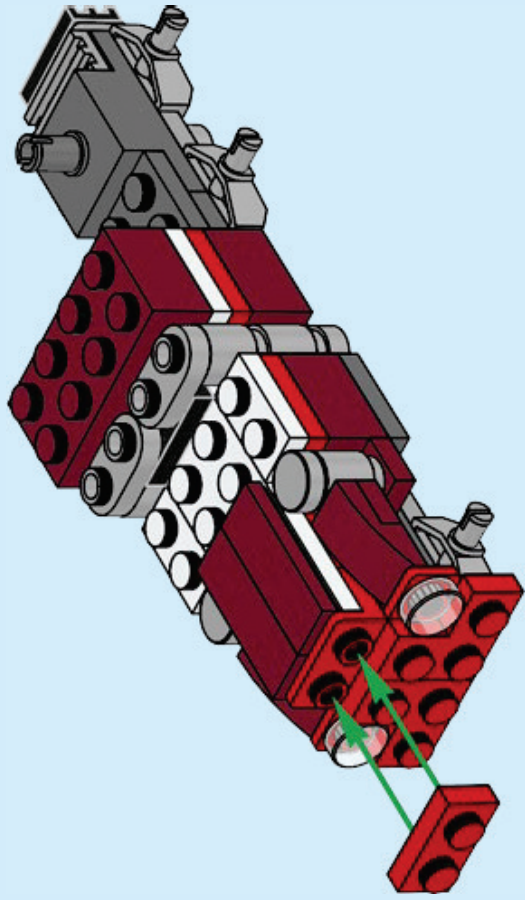

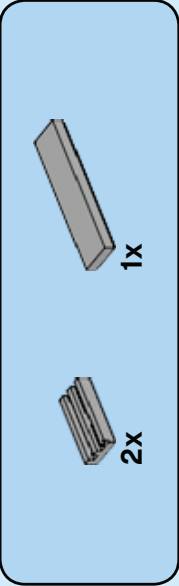

23

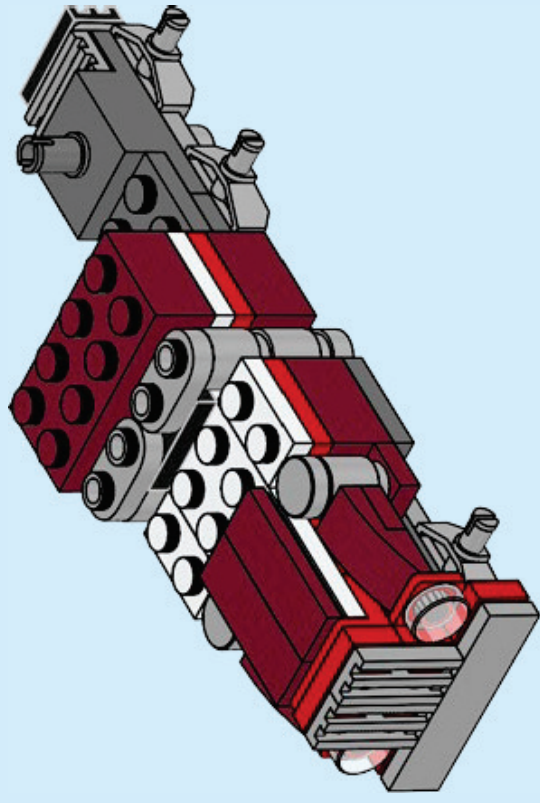

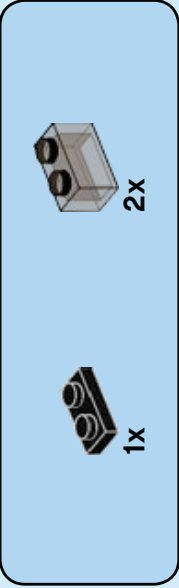

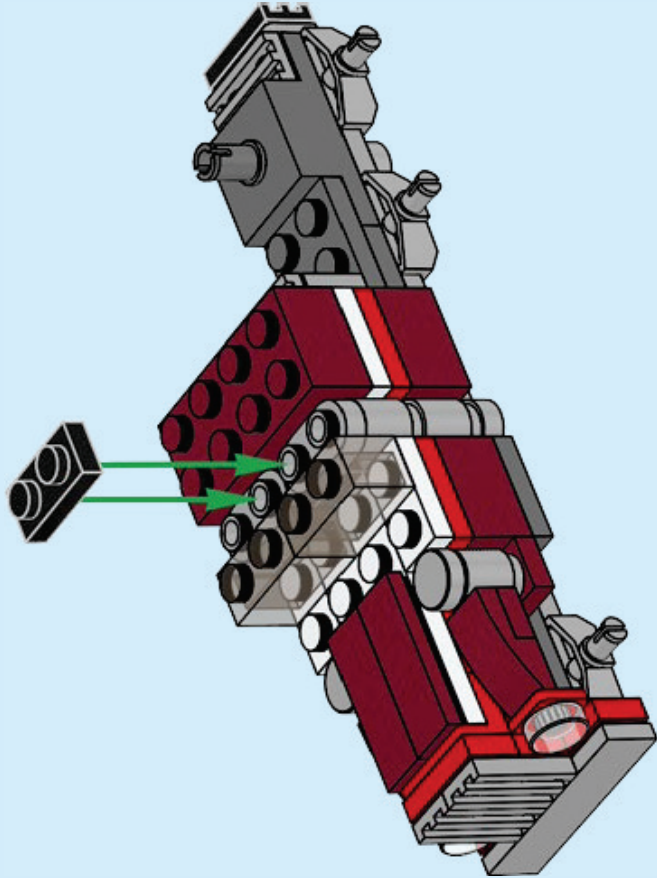

24

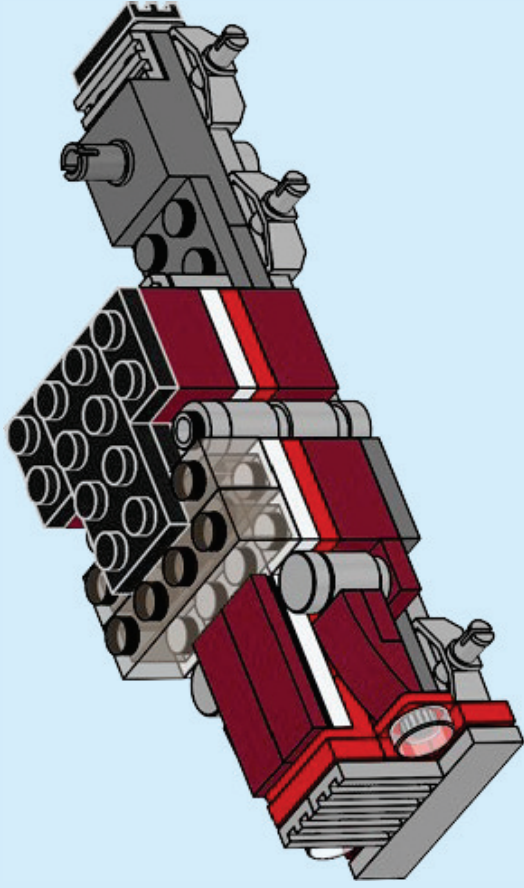

25



2x  2x 

26

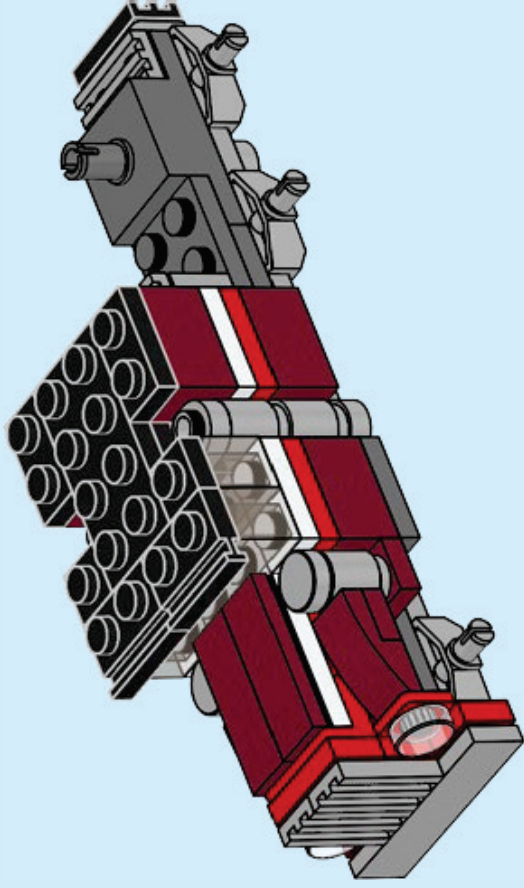

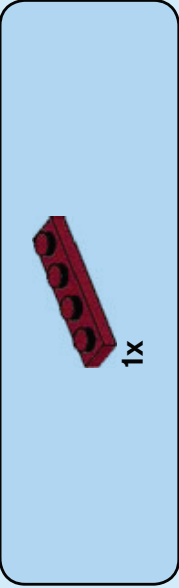

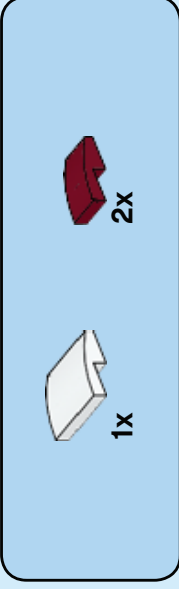
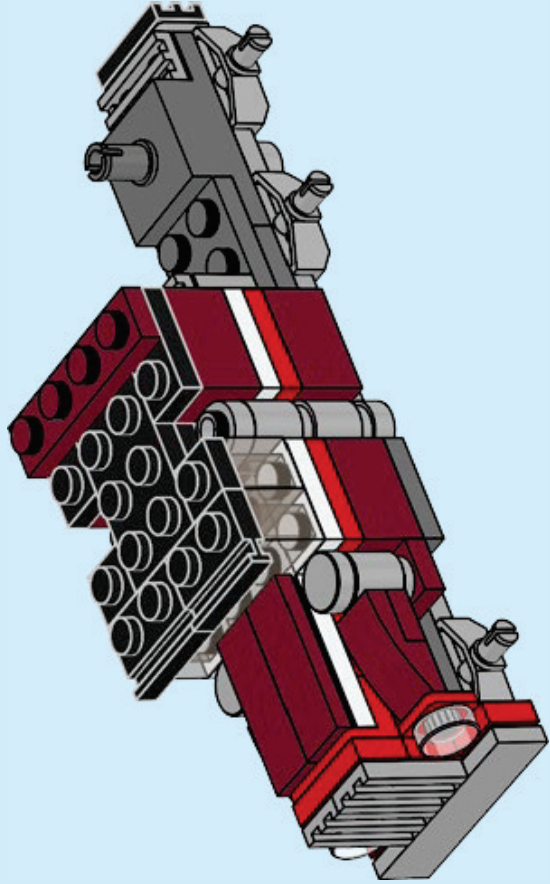

27

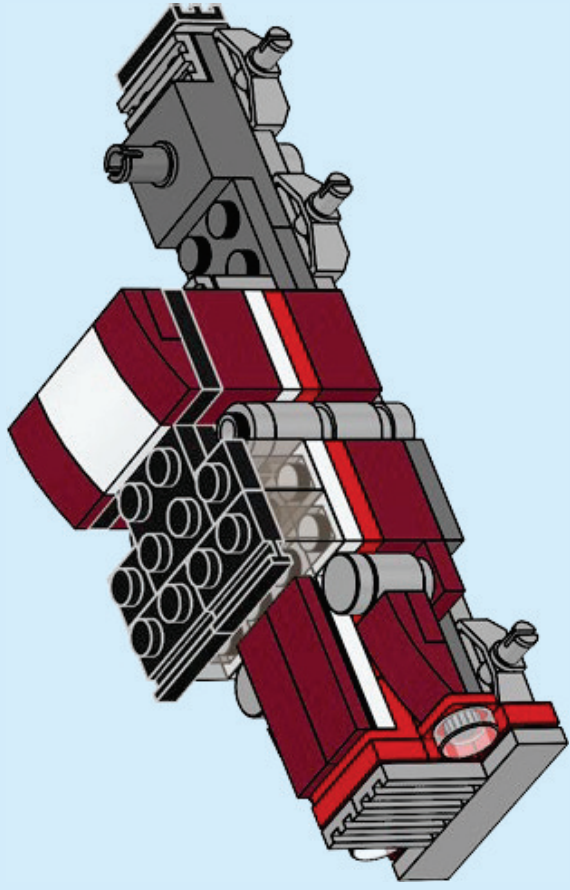

28



1x  2x 

29

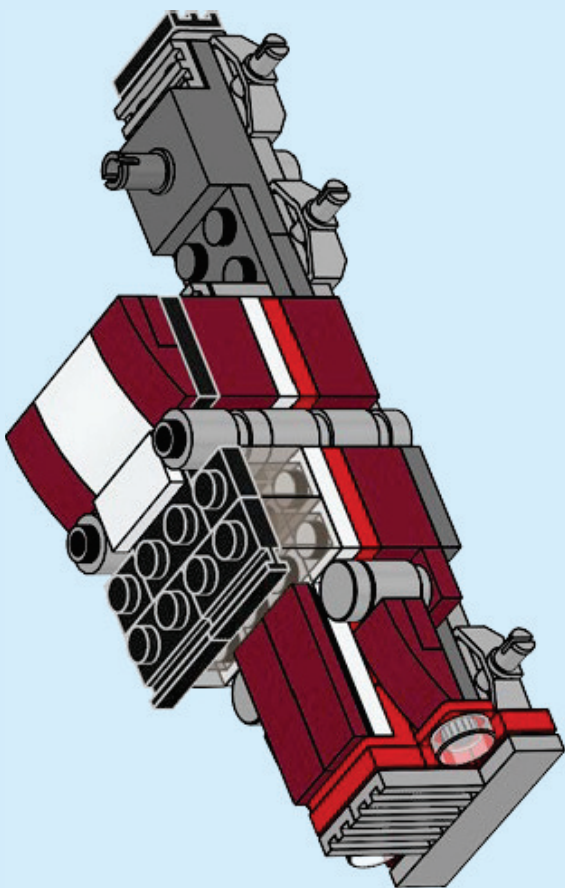

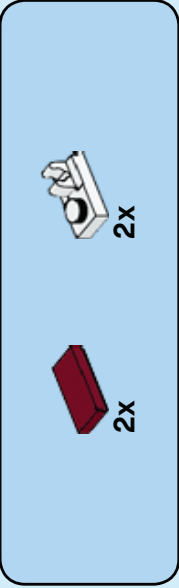

30

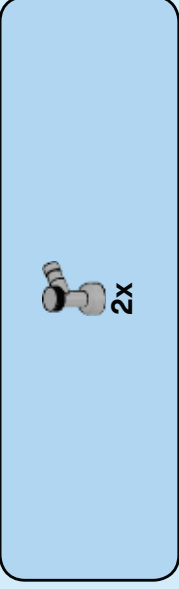
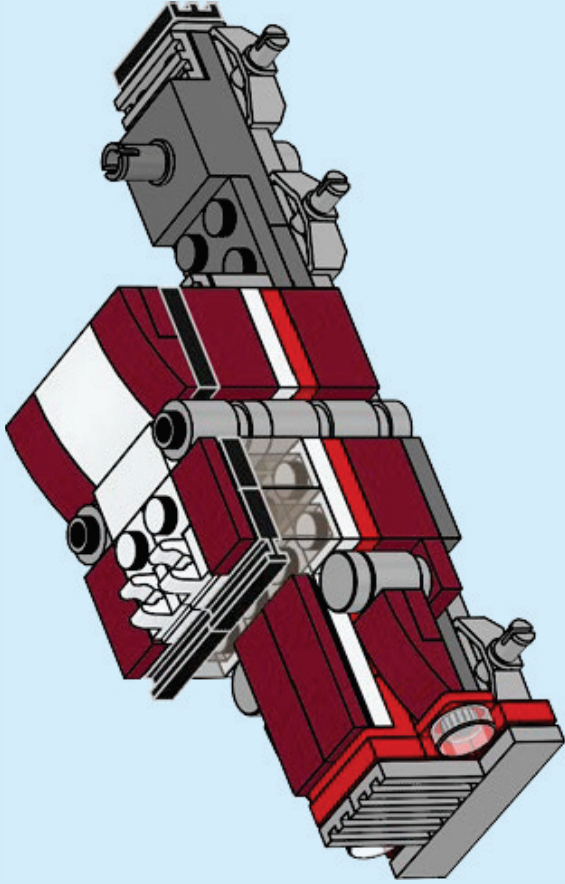

31

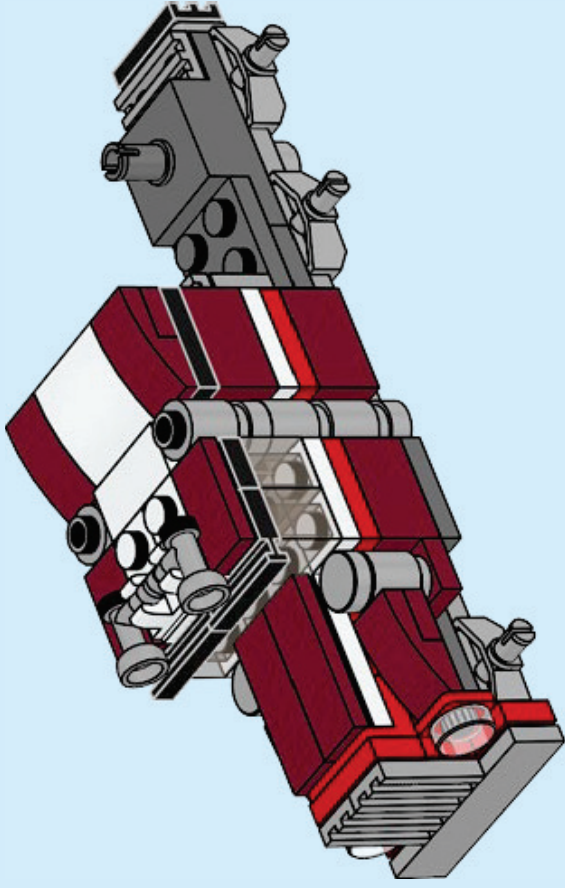

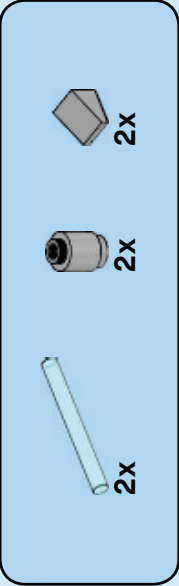

32

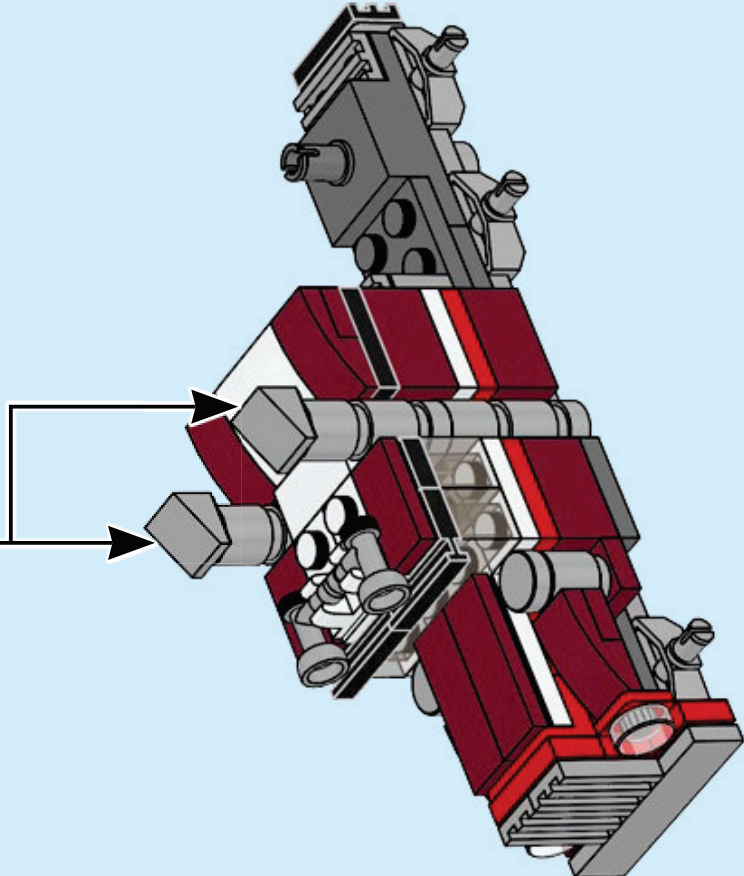
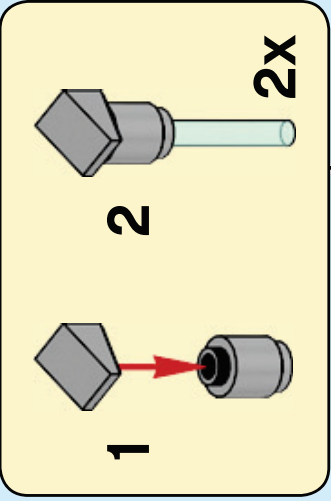

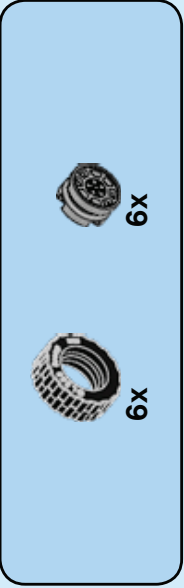

33

